



QUICK START GUIDE G SERIES



ACTIVE & HITECH

EN - 6B

VALTRA

YOUR WORKING MACHINE

VALTRA G SERIES ACTIVE & HITECH

This quick start guide offers simple tips for getting the most out of your Valtra G Series tractor. Please note that this is NOT an operator's manual. Before operating the tractor, it is important that you read the operator's manual with all safety points.

With a state-of-the-art tractor there has to be also a reliable transmission. G series HiTech and Active have a Powershift transmission with 4 ranges and 6 powershift steps. The high level automatics included in this tractor brings the driving of a powershift tractor to a completely new level. The most modern way of driving is combined to mechanically controlled working hydraulics. All that together with market leading operating comfort in a totally new cab gives you the driving experience of a lifetime.

- Revolutionary Powershift (6PS / 24+24 / 48 + 48)
- Open centre (HiTech) or Load Sensing (Active) hydraulics with mechanical control
- Hydraulic assistant with front valves
- Very easy to operate
- HillHold and many other transmission features
- Made in Finland by Valtra

VALTRA



YOUR

Valtra ARM explanation	4
Side panel & Side panel connectors	5
A-B-C-D four speed ranges	6
How to select speed range	7
How to select Powershift gear	8
Driving with gear lever.....	9
Auto shift	10
Features	12
AutoTraction	13
HillHold	14
EcoPower mode	15
Cruise Control	16
Engine RPM cruise	17
Hydraulics - rear valves	18
Optional front hydraulic	19
Hydraulics - front valve operations	20
Front loader work	21
Hydraulic assistant	22
PTO	23
PTO Tips	24
Rear controls and connections	25
Pick-up hitch	26

WORKING

Pulling work on the field	27
Transport on the road	28
PTO work Auto 1	29

MACHINE

Gease points	30
Daily checks	31
Tips	32
Instrument cluster & Setting menus	34
Settings and operations	35

YOUR WORKING MACHINE



VALTRA ARM & SIDE PANEL

DRIVER'S ARMREST

1. Front hydraulics on/off button
2. Button for hydraulic implement locking
3. Button for SoftDrive
4. Changeover button for front lift / front loader
5. Joystick
6. Hand throttle
7. Gear lever
8. PowerShift limit push button
9. Cruise control (off, memory 2, memory 1)
10. Cruise control speed adjustment wheel
11. Autocontrol (lift/stop/lower switch)
12. Position Control override button for Quick drop/entry
13. AutoGuide remote activation button
14. Engine RPM memory button
15. Position control knob
16. Switch for front PTO
17. Switch for rear PTO when front PTO is included
18. Joystick fingertip lever for auxiliary hydraulics front valve 3F (optional)

- Driving / transmission
- Hydraulics
- 3-point linkage
- Power take-off
- Electrics

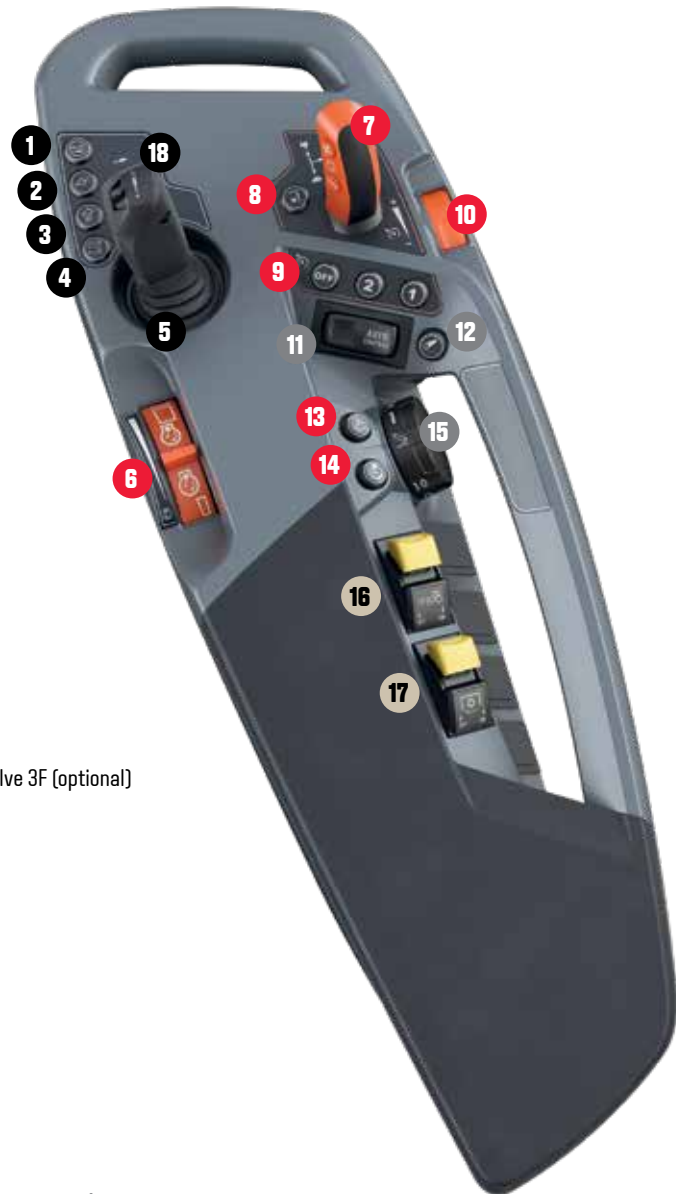

SIDE PANEL

1. Control lever for auxiliary hydraulic valve 1 and 2 (STD)
2. Control lever for auxiliary hydraulic valve 3 (option)
3. Control switches to limit valve use /detent position
4. Auto PTO push button
5. PTO speed control knob
6. Lowering speed selector
7. Max lifting height selector
8. Draft control selector
9. Drive balance control knob /optional slip control
10. Switch for lift / lower the lower links
11. Flow control adjustment knob
12. Release lever for pick up hitch
13. Switch for 4WD (OFF-AUTO-ON)
14. Differential lock (OFF-AUTO-ON)
15. Button for shifting automatics AUTO 1-2
16. Button for EcoPower mode (G125)
17. Button for Valtra Guide (optional)
18. Button for QuickSteer (optional)
19. Switch for ON/OFF valve (quick couplers, option)
20. Switch for ON/OFF valve (pick-up hitch hydraulic push-back, option)

SIDE PANEL CONNECTORS

1. Three -pin current socket (25A) – standard equipment
2. Cigarette lighter (10A) (option)
3. USB –socket (option)
4. Power ON/OFF switch for number 5 (option)
5. 10A power socket (option)
6. 10A power socket (option)
7. Connector for SmartTouch Extend (option)
8. Connector for ISOBUS terminal (option)
9. Implement signal connection ISO11786 (option)
10. Socket for camera connection (option reverse camera readiness 64256400, Versu only)

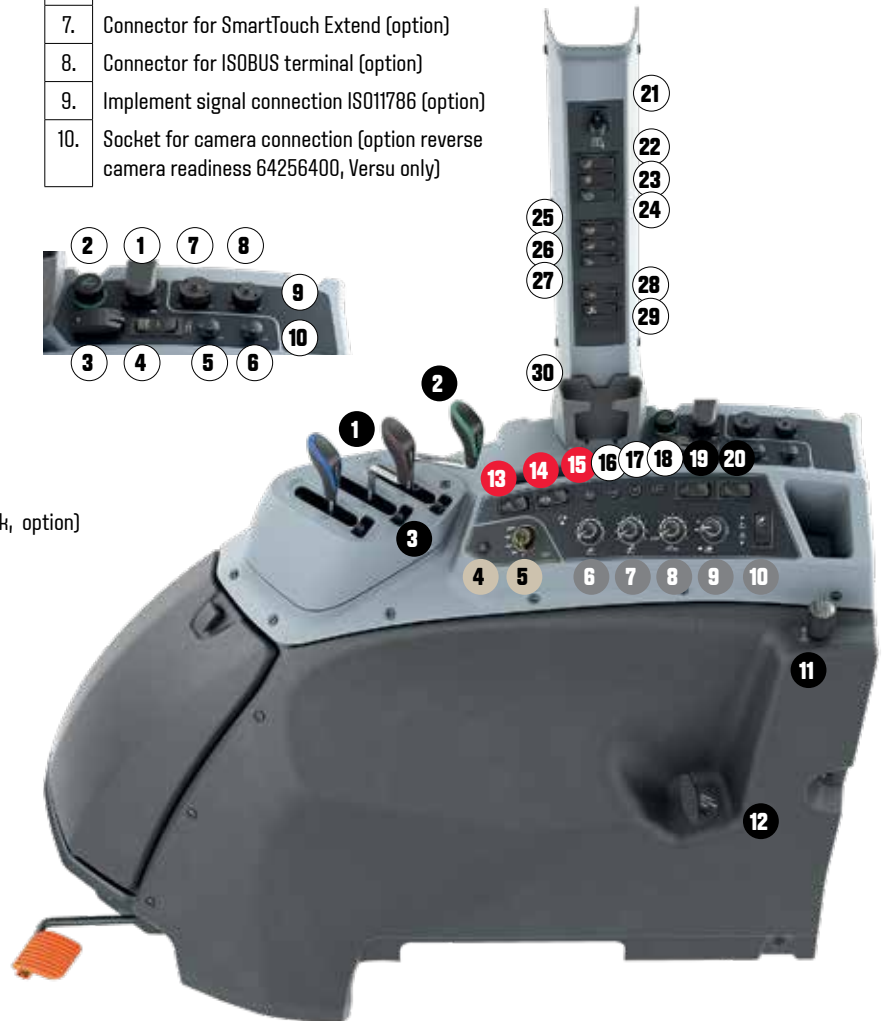

SIDE PILLAR

21. Mirror adjustment switch (option)
22. Mirror heater switch (option)
23. Rear window heater (option)
24. Rear window wiper and washer (option)
25. Rotary beacon(s) (option)
26. Front work lights
27. Rear work lights (if optional automatics, OFF-AUTO-ON)
28. Additional lower heater (option)
29. Front axle suspension control (option)
30. Mobile phone holder

A-B-C-D

FOUR SPEED RANGES

Four speed ranges – less strain = increased efficiency.
With a choice of speed ranges YOU can set the transmission to work as effectively as possible, cutting fuel usage and increasing component life. Creeper is optional.

	Speeds on optional creeper	Standard speeds	Faster D speeds on EcoSpeed
A	0.1 - 0.3 km/h	1 - 4 km/h	
B	0.2 - 0.8 km/h	3 - 11 km/h	
C	0.4 - 1.6 km/h	6 - 22 km/h	
D	0.9 - 3.7 km/h	13 - 43 km/h	15 - 43 km/h
Top speed will be reached on engine speed, r/min		1910	1640

HOW TO SELECT SPEED RANGE

Selecting the correct speed range for the task means that the tractor will perform best of its ability.



TO CHANGE RANGE

- Simply push + or - button located on gear lever or use the lower rocker switch on the basic handle.

These processes can also be conducted whilst moving.

CREEPER RANGE SELECTION

- Go to range A; Press the clutch pedal fully down and keep it down. Speed must be 0. Press the minus button.
- See engaged range from the dash

SELECTING AUTOMATIC SPEED RANGE CHANGE

- Push on dash control panel ARROW RIGHT once
- Push ◀ OR ▶ to get to TRANSMISSION screen
- Press ▼ (or ▲) to get on right line to adjust, Note that transmission screen has 2 pages - press OK
- Set with ◀ OR ▶ to set automatic change ON or OFF C > D and B > C can be set separately
- Push OK to quit editing

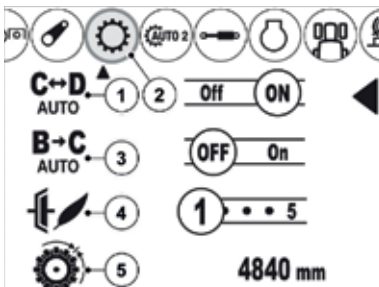

HOW TO SELECT POWERSHIFT GEAR

1.

To change the Powershift gear in manual mode (move gear lever to the left position) simply push the gear lever forward to increase the Powershift gear or backward to decrease the Powershift gear.

2.

You can change the Powershift gear more than one step at a time, directly from 1 to 3 for example, by quickly moving the gear lever to either direction twice or more.

3.

You can also change the Powershift gear several steps at a time by moving the gear lever / rocker switch in either direction and holding it there, which triggers multiple consecutive Powershift gear changes. The number of the selected Powershift gear blinks on the A-pillar display until the requested Powershift gear has engaged.



These processes can also be conducted whilst moving.

You can preprogram the desired Powershift gear to engage automatically when changing the driving direction. For example, when working with the front loader and changing the direction to forwards, Powershift 1 can be engaged, and when changing the direction to backwards, Powershift 3 can be engaged. See page 12.



On middle in the dash you can find the information of selected gear, even shuttle is on N or P!

DRIVING WITH GEAR LEVER



DRIVING VALTRA HITECH AND ACTIVE IS EXTREMELY EASY

1. Start the engine with the clutch pedal depressed and release the clutch pedal.
2. Select the desired range (C-range is default).
3. Move the shuttle to the forward/reverse position to initiate drive.
4. Change the powershift using the gear lever on the ARM rest.
5. Push/pull and hold the gear lever / rocker switch and the tractor will change up/down as quickly as possible.

TIP You can use the HillHold function (see page 14) by pressing the brake pedals when selecting the direction.

AUTO-SHIFT

(AUTO-1)

This feature let the tractor manage the gear changes within a range, or if B C and/or C D automatics activated, between A1 or C1 and D6, including changing the range automatically when required. From C to B the change is always manual. When driving with Auto 1 the accelerator pedal is changing into drive pedal. That means that the pedal is asking for speed, not engine revs. When driving with a light load, keeping the drive pedal in the same position, the tractor automatically changes bigger gears without changing the speed. This means that engine revs decrease and you save fuel!

TO CHANGE POWERSHIFT GEAR AUTOMATICALLY

1. Simply push gear lever to the right.
2. The symbol Auto1 will appear on the A-pillar display.
3. When drive is initiated, the tractor will automatically shift between the gears depending on the speed.
4. Automatic shifting between the speed ranges B, C and D are possible if you have activated the B > C and C < > D shifting automatics functionality in the transmission settings.
5. If you wish to alter the RPM at which the tractor changes up/down gears you can use Auto2 mode. Change between Auto1 and Auto2 with the button located in side panel.



AUTO-SHIFT (AUTO-2)

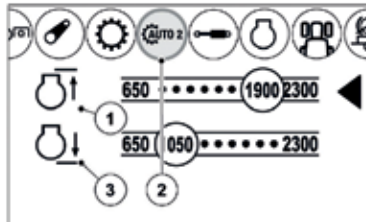

- 1. RPM value for shifting up
- 3. RPM value for shifting down

SETTING AUTO-2

1. Push on dash control panel once
2. Push or to get to AUTO 2 screen
3. Press or to get on right line to adjust, press OK
4. Set with or to adjust the engine RPM for gear change
Upper line is RPM value for shifting up
Lower line is RPM value for shifting down
5. Push OK to quit editing

FEATURES

POWERSHIFT REVOLUTION

Your Valtra tractor is packed with features to make your working day easier...

LIMITING MAX. POWERSHIFT GEAR

Limit max desired powershift gear with the push button next to the gear lever.

1. Push the button (1) shortly when driving desired max gear. Tractor must be moving and automatic powershift engaged.
2. No bigger gear will go on when driving. The gear set as the limit appears in dash, upper left corner.
3. Extremely good e.g. in arable tasks to avoid continuous powershift gear changes.

PREPROGRAMMING GEAR FOR DRIVING DIRECTION CHANGING

You can preprogramme the desired Powershift gear to engage automatically when changing the driving direction. For example, when working with the front loader and changing the direction to forwards, Powershift 1 can be engaged, and when changing the direction to backwards, Powershift 3 can be engaged.

1. Press down the clutch and brake pedals to ensure safety (engine must be running!)
2. Select the driving direction F or R with the power shuttle lever.
3. Select the Powershift gear.
4. Press the Powershift preprogramming push button (2) for half a second.
5. The dash (5) shows the driving direction and the gear which is pre-programmed to it

To cancel the preprogramming:

1. Press down the clutch and brake pedals to ensure safety.
2. Select the driving direction F or R with the power shuttle lever.
3. Push the preprogramming button for 2 seconds.

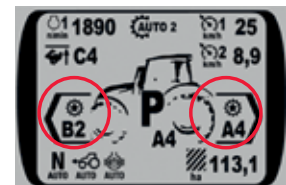
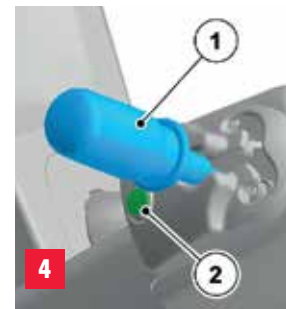

5

NOTE: Even if the power is turned off, the pre-programming remains. You can programme the other driving direction in the same way. You can make the preprogramming also while driving, except when the creeper gear is engaged.

POWERSHIFT REVOLUTION

AUTOTRACTION





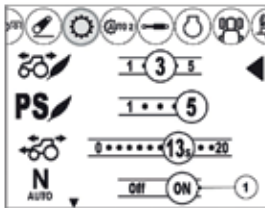

STANDARD FEATURE

Standard AutoTraction - a feature that revolutionizes the driving of a powershift tractor. With a Active or HiTech tractor you need the clutch pedal only when starting the engine. Otherwise you need only brakes and drive pedal for controlling the tractor. The drive is declutched simply by pressing the brakes and clutched again by releasing them. The most intuitive and easy way to drive a powershift tractor in the market!

Conditions for declutching the drive with coupled brake pedals:
Speed is less than 20 km/h, engine is not in engine braking and accelerator pedal is not used.



AUTOTRACTION CAN BE ACTIVATED OR DEACTIVATED AS FOLLOWS

1. Push on dash control panel  once
2. Push  OR  to get to TRANSMISSION screen
3. Press  or  to get on line N, press OK
4. Set with  OR  to set between ON or OFF
5. Push OK to quit editing

TIP Try using when baling, or on stop start operations to minimize clutch use. Can also be used on road operation

POWERSHIFT REVOLUTION

HILLHOLD

STANDARD FEATURE

The new HillHold function is a standard feature in Active and HiTech tractors. With this function you don't have to keep the brakes pressed down when the tractor is standing still in up- or downhill, for example when waiting for turn in a junction. HillHold can be activated easily:



1. Stop the tractor by pressing the brakes
2. Keep brake pedals depressed, put the shuttle lever FIRST to P and then put the direction (F or R) on again
3. Release the brakes
4. Tractor stays in stationary even with load or trailer
5. Make a hill start just by pressing the accelerator pedal

ECOPOWER-MODE

Only on G125 models

ECO mode is designed especially for work that requires high torque, but not constant engine revs e.g. pulling work on the field. With EcoPower the tractor will give highest torque already at very low engine revs. EcoPower lowers the engine speed by 200rpm without affecting the engine max. power. This allows lower noise levels and lower fuel consumption. If higher engine revs are needed, you can change between ECO and power mode with ECO push button on the side panel.

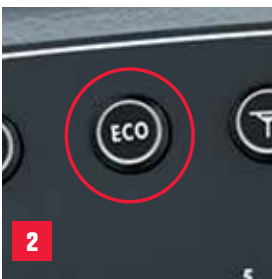

1. Make sure the engine is running.
2. Push the ECO-button from the right-hand console.
3. You will notice the maximum engine RPM drop and the switch will illuminate green.
4. Use this when operating on the road, or when using implements with high torque requirement.
5. To deactivate, push the ECO button.

CRUISE CONTROL

Traditionally most drivers have used the hand throttle to hold a steady speed, especially on the road. Cruise disengages automatically when clutch or brakes are depressed.

NOTE There are two independent memory slots, e.g. one speed for field and another for headland.

TO SET CRUISE CONTROL WHILST MOVING

1. Hold the desired speed steady and press the cruise control button 1 (or 2) shortly* at the same time.
2. Cruise will engage and a symbol will appear on the dashboard.
3. Adjust the stored speed with the cruise control adjustment wheel.
4. To cancel the cruise control, depress brakes, clutch or push the OFF button located on the armrest. Speed can be increased momentarily using the drive pedal without deactivating the cruise.



NOTE If there is a value in speed cruise memory, you need to push the cruise control button 1 or 2 for 2 seconds to overwrite the value.

ENGINE RPM CRUISE

Valtra Active and HiTech have cruise control also for engine RPM that will keep engine RPM constant regardless of speed. Engine RPM cruise can be stored whilst stationary or moving.



2

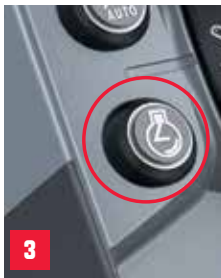

3



4

1. Make sure the engine is running.
2. Increase the engine RPM to the desired level by using the hand throttle (or accelerator pedal).
3. Push and hold the engine RPM button until the cruise light stays on in the dash.
4. Release the button and RPM will be stored. Also return hand throttle to minimum.
5. The engine RPM should now stay at the set level.
6. Push the engine RPM cruise control button to engage and disengage the RPM memory function.

NOTE In PTO-use the engine speed memory can be used as PTO cruise, which recalls automatically the selected PTO's nominal speed, see page 24.

HYDRAULICS

REAR VALVES

In HiTech you have Open Centre and in Active Load Sensing hydraulics, both with mechanically controlled rear valves. All valves have a floating function (the frontmost position) as well as kick-out function (pressure return).



In tractors with three rear valves, there is a flow control knob in the rear of side panel. With it you can control the brown valve flow between 1 to 80 l/min.



Location of the rear valve quick couplers.

1. Valve No 1 (blue)
2. Valve No 2 (brown)
3. Valve No 3 (green, optional)
4. ON/OFF valve (this is an option, a fourth valve with limited flow and rocker switch control)

If 3 valves selected, the valve 2 (brown) has a flow control

NOTE that valves have a zero leak function in + port, meaning no internal leakage – work cylinder keeps it's position.

OPTIONAL FRONT HYDRAULICS

You can use Joystick to control front loader or front lift operations



1.

Every time tractor is turned on, the spools must also be turned on using the ON/OFF button located on the left side of the joystick.



2.

Front lift or a pair of front quick couplers can be operated also from rear valves, if such option is selected.

A function in question will be controlled with blue lever (first valve in cab, selector in rear must be in position 2).

NOTE If there is no front loader or front valves selected, there is no joystick in armrest.



NOTE If you have opted for front lift or other front function from rear valves, blue quick coupler in the rear can not be used if selector is in position 2.

HYDRAULICS

FRONT VALVE OPERATIONS

FRONT LOADER

1. With Joystick you can use front loader beam (A) and loader implement tilt (B) functions
2. If live 3 is selected, use the “trigger” (C) to control live 3 function

FRONT LIFT

1. With Joystick you can use front lift up and down (A) and 1st pair of quick couplers (B)
2. The “trigger” (C) can be used for control of 2nd pair of quick couplers

FRONT LOADER AND FRONT LIFT

3. With Joystick (A) you can use loader or front lift up and down (select which you use by toggle switch (1/2))
4. With Joystick (B) you can use loader implement tilt or 1st pair of quick couplers functions (select which you use by toggle switch (1/2))
5. The “trigger” (C) can be used for control of live 3 or 2nd pair of quick couplers, accordingly

Front hydraulic functions are all optional. If you opted a function “from rear valves” it will be controlled with blue valve.

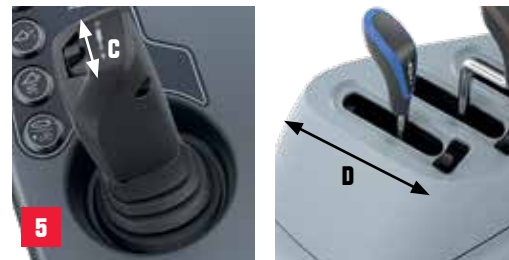
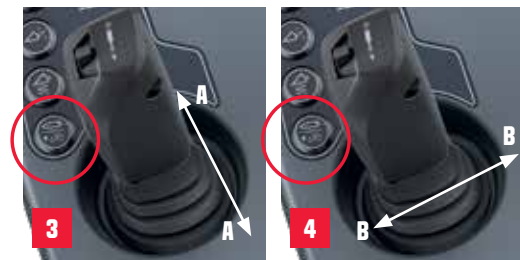
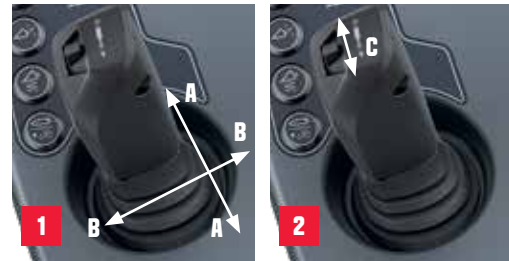



FRONT LOADER WORK

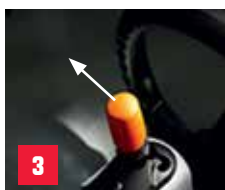

1. Start the engine with the clutch pedal depressed.
2. Select the desired range (B or C recommended).
3. Move the shuttle to the forward/reverse position to initiate drive.
4. Activate hydraulics (with Valtra ARM).
5. Activate hydraulic assistant from dashboard hydraulic setting menu
6. Adjust/limit hydraulic flow from dashboard setting menu if needed
7. Start working
8. To make work more effective, you can pre-program the start speeds both forward and reverse (see page 12)

HYDRAULIC ASSISTANT

BOOSTING YOUR FRONT LOADER USE

Valtra is the first Powershift tractor in the world with patented hydraulic assistant! Engine revs are rising when hydraulic flow is required from front valves (electric valves), even when driving - without affecting the ground speed.

You can set Hydraulic assistant ON or OFF from hydraulic settings -menu.

For some operations with front implements the movements can be too fast - even with deactivated assistant - so you can set the maximum flow for each front valve from the same settings. IN and OUT can be set separately! Note also that you can set the operation time for front valves.

HYDRAULIC ASSISTANT MAKES OPERATION WITH FRONT LOADER FASTER AND MORE AGILE:

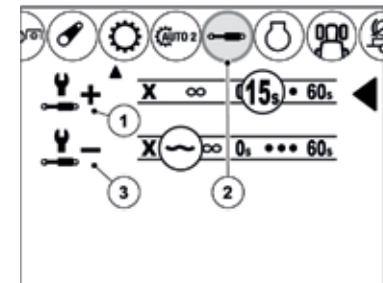
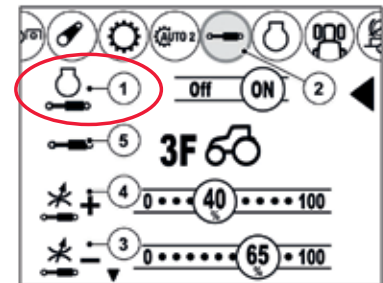

1. No longer does the operator have to press accelerator pedal and brake pedal at the same time.
2. The hydraulic assistant increases engine revs automatically when driving with powershift 2 or higher.
3. Works also when the brake or clutch pedals are pressed or the shuttle in neutral.
4. Assistant works also in the move when using AUTO 1

PTO

The rear PTO can have 2 or 3 speeds and in addition optional Ground Speed PTO. **Before using PTO:** it is important that you study first the safety guidelines from Users Manual!

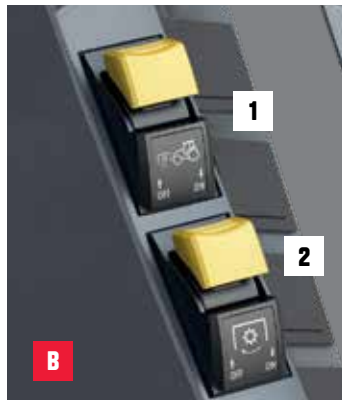

- | | |
|----|---|
| 1. | Front PTO switch (option).
If no Front PTO, the rear PTO in this place |
| 2. | Rear PTO
(if front PTO fitted) |

START THE REAR PTO

1. Select an applicable speed with the knob in side panel (A)
2. Press and hold the rear PTO switch in armrest (B) and move it rearward to start the PTO operation.
3. To start the rear PTO with the external controls, push and hold the PTO ON/OFF button for 3 seconds.

PTO speed shows on the right instrument display.

STOP THE REAR PTO

1. Press and hold the rear PTO switch and move it forward to stop the PTO operation. Then release the switch.
2. To stop the rear PTO with the external controls, press the ON/OFF button one time

NOTE The optional front PTO has only 1000 r/min speed. To start and stop only use the front PTO switch in armrest. If both PTOs are in use, display shows the rear PTO speed.

NOTE Use the optional Ground speed PTO only in speeds less than 20 km/h. To disengage ground speed PTO the tractor must also be stopped and knob A to be turned on N.

PTO TIPS

STATIONARY MODE OF THE PTO

You can engage the stationary mode of the PTO and it then operates even when you are not on the operator's seat.

1. Park the tractor and apply the parking brake.
Engage the PTO.
2. To operate the PTO in stationary mode, push and hold the front PTO or the rear PTO switch for 3 seconds.
Then you can leave the drivers seat

PTO CRUISE

When PTO cruise is activated from PTO setting menu (A), to engage PTO cruise, press the Engine speed memory button on the armrest when PTO in operation. The PTO cruise control accelerates then the PTO at the nominal speed of the selected PTO. Can be set and used also for front PTO. If both PTO's in use, the lower engine speed of these two is used.

AUTO PTO

The automatic PTO function lets you set the limits to automatically stop and start the rear PTO when lifting and lowering the rear lift. You can set limits for disengage when you lift and for re-engage when you lower the rear linkage from PTO setting menu.

To Start:

1. The rear PTO operates and proper ON/OFF limits are set in dash (C and D)
2. Rear linkage is lowered to work position
3. The tractor is in motion, more than 1 km/h.
4. Press the button for automatic start/stop for the PTO on the side panel (G)

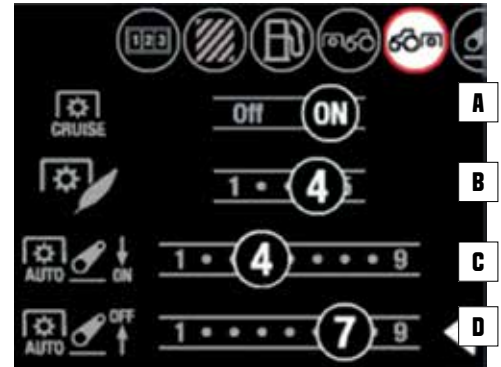

REAR CONTROLS AND CONNECTIONS

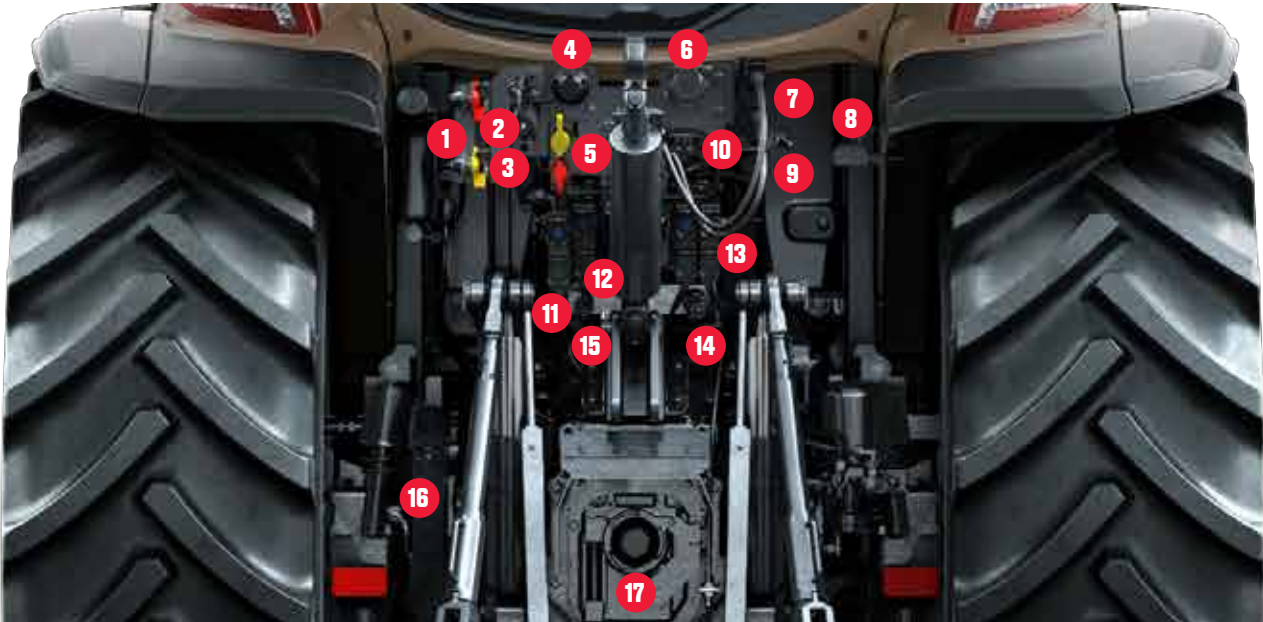

1.	2-line trailer air brake couplings (option)*	9.	Valve to isolate the front hydraulics from valve 2 (option)
2.	Power Beyond couplings (Active only, option)	10.	ISOBUS connector (option)
3.	Compressed air outlet (option)	11.	Auxiliary hydraulics: Quick couplings valve 1
4.	Trailer lights socket	12.	Auxiliary hydraulics: Quick couplings valve 2
5.	Quick couplings for hydraulic 2-line trailer brakes (option)*. Upper coupling works also for 1-line hydraulic brakes	13.	Auxiliary hydraulics: Quick couplings valve 3 (option)
6.	ABS-brakes trailer socket 12V (option)	14.	Free return coupling (1", Active only)
7.	Auxiliary hydraulics: Quick couplings for electric ON/OFF valve (option). Used in picture for Hydraulic Top Link (option)	15.	Free return coupling ½"
8.	Hitch light (option)	16.	Drawbar for pick-up hitch (option), NOTE Trailer hitch types vary from market to market.
		17.	Sight glass for checking hydraulic oil

*) According EU regulation a tractor has to have 2-line trailer brakes (pneumatic OR hydraulic) to be able to tow heavier trailers. Air couplers may also vary from country to country.

PICK-UP HITCH

UNLATCH THE PICK-UP HITCH

PROCEDURE

1. Push the top side of the lifting/lowering switch to fully lift the linkage.
2. To unlatch the hitch, pull the hitch release lever and at the same time push the bottom side of the lifting/lowering switch.
3. Release the hitch release lever when the hitch is below the locking latch

TO LOCK THE PICK-UP HITCH:

4. Push the top side of the lifting/lowering switch or the lifting push button until the hitch latches. You can hear a click.

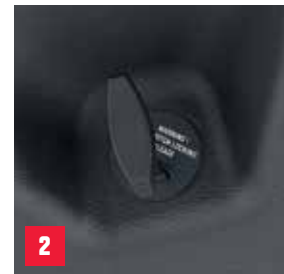

1. Lifting/lowering switch
2. Hitch release lever



PULLING WORK ON THE FIELD

HIGH NEED FOR POWER, LOWER SPEED



1. Start the engine.
2. Select the B range using the + and – buttons.
3. Switch 4WD ON (symbol side position) and set differential lock to AUTO. (MID-position).
4. Activate Auto 1.
5. Limit max desired powershift gear if needed (with Valtra ARM).
6. Optional: Set Auto-2 according to the task (see page 10).
7. Select driving direction by using the shuttle lever.
8. Press the accelerator pedal.



TRANSPORT ON ROAD

HIGH NEED FOR SPEED, TEMPORARY NEED FOR FULL POWER

1. Start the engine.
2. Select the desired range according to the situation (max C range always when start driving).
3. Switch 4WD to OFF when driving on the road (slippery conditions: keep 4WD on all time)
4. Optional: Set speed cruise when moving (with Valtra ARM).
5. Optional: Set Auto-1 by moving to right position if you want tractor to manage Powershift changes automatically between C1-D6.
6. Select driving direction using the shuttle lever and press accelerator pedal.





PTO WORK

AUTO 1

**PTO USE – HIGH POWER NEEDED
– MEDIUM/HIGH SPEEDS**

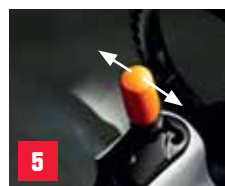

1. Start the engine.
2. Select range B or C.
3. Select PTO speed and start PTO.
4. Set the right PTO speed and put it into the Engine RPM memory with a push longer than 2 seconds.
5. Select driving direction using the shuttle lever.
6. Set Auto1 on.
7. Control powershift gears (=speed) with drive pedal or hand throttle (pedal fully up gives PS1 and fully pressed down gives PS6).

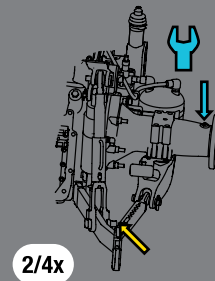
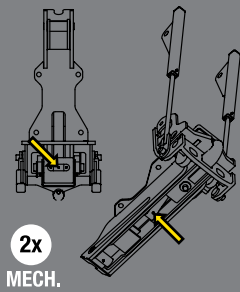
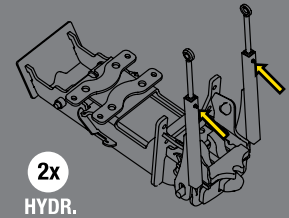
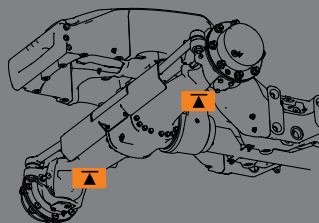
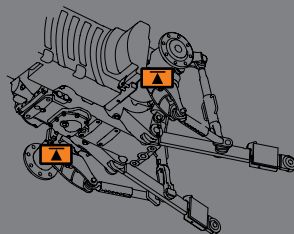
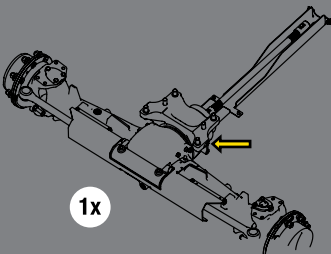
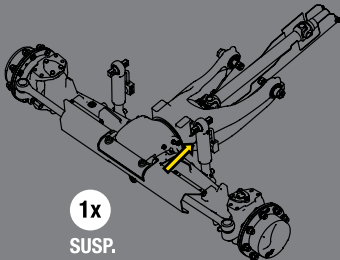
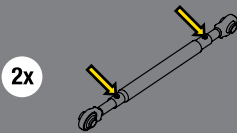
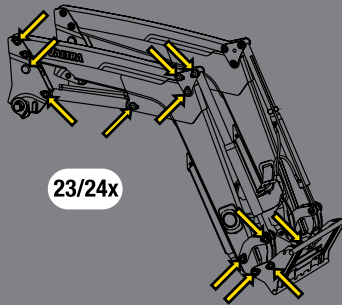
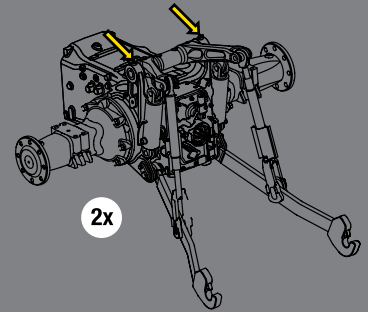
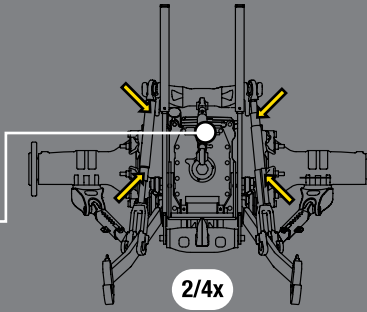
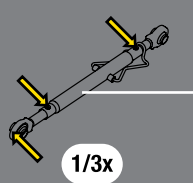
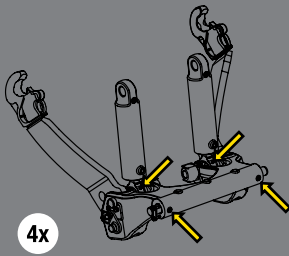

GREASE POINTS

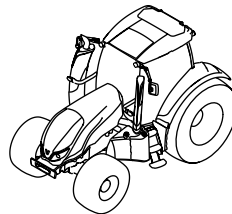

- 50h /weekly
- Every 500h
- Support points

DAILY CHECKS

Before starting the daily work, make sure that the following daily maintenance checks are done.



1. Check the engine oil level.

2. Check the coolant level (under hood).

3. Check the radiators and if necessary, clean them through openings (via latches under hood, both sides).

4. Check the oil level in the transmission and hydraulic system (sight glass next to PTO).

5. Drain the water from the compressed air system (option), air tank is in the front of the rear axle.

6. Check the tyre pressure.



HITECH & ACTIVE TIPS

DRIVING TIPS

The Powershift revolution arguments for Versu tractors can be easily explained. The powershift revolution offers operator features that are not common in powershift tractors.

Standard Auto-Traction

A feature that revolutionizes the driving of a powershift tractor. With a HiTech/ Active tractor you need the clutch pedal only when starting the engine. Otherwise you need only brakes and drive pedal for controlling the tractor. The drive is declutched simply by pressing the brakes and clutched again by releasing them. The most intuitive and easy way to drive a powershift tractor in the market!

HillHold

This feature is for operation in varying conditions, Valtra offers a standard HillHold feature. The hill-hold assist helps to prevent the tractor from going backwards unintentionally when starting on steep slopes. With this function you don't have to keep the brakes pressed down when the tractor is standing still in up- or downhill, for example waiting your turn in a junction.

Automatic shifting Auto 1 and Auto 2

This feature lets the tractor manage the gear changes within a range, or if activated, between C1 and D6, including changing the range automatically when required.

Engine braking

When Driving with Auto 1 you can even set engine braking to fit the work or road conditions.

Gear lever (with Valtra ARM)

+ The Powershift transmissions can now be operated with a gear lever. When the gear lever is pulled to the left, the manual mode is activated and on the right position the automatic mode is on. This feature gives the operator a lot of flexibility in choosing the optimal mode for different tasks and situations.



Load-sensing hydraulics in Active models increase effectivity of working with implements

- + By offering just the needed amount of oil and pressure through the valve, fuel consumption decreases and the need for cooling the oil is smaller.
- + Load-sensing hydraulic system enables several functions to be used simultaneously while maintaining stable hydraulic oil output regardless of the engine revs.

Hydraulic assistant makes operation with front loader faster and more agile

- + No longer does the operator have to press the accelerator pedal and brake pedal at the same time.
- + The hydraulic assistant with front valves increases engine revs automatically when the brake pedal is pressed or the clutch is being lifted slowly.

By choosing ECO mode you can save fuel (G125e model)

- + The tractor will give huge torque already with low engine revs. By driving with lower engine revs you save fuel.
- + On uphill the speed will be a bit lower than in Power mode, but you can choose either to save a few seconds of time or fuel.

INSTRUMENT CLUSTER

Left dash is a real information and setting centre in HiTech and Active models. Drive Display shows all transmission functions selected as well as many other information



To settings



To start-up screen

Drive display



Start-up screen



to settings

SETTING MENUS

Here an overview of different settings (HiTech, Active).



Front PTO

Rear PTO smoothness and automatics

Rear lift slip control (optional in Active)



Transmission page 1

AUTO 2 set

Front hydraulic settings (optional)

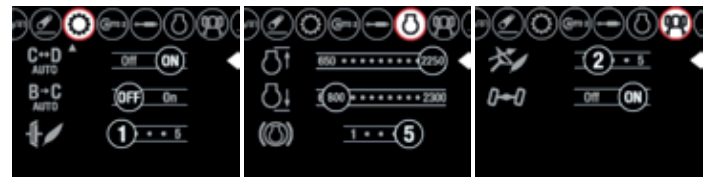

Transmission page 2

Engine and engine braking setting

Front axle (Active or QuickSteer models only)



Trailer brake test (see user manual)

SETTINGS AND OPERATIONS



Active regeneration - used usually only before engine oil change. Will signal light be lit - see user manual "Troubleshooting" chapter for details



Terminal settings like brightness

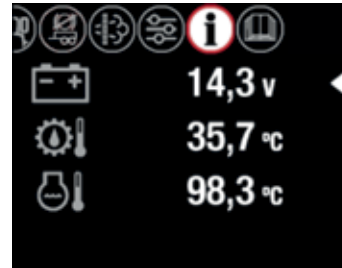

Information about:

- Voltage
- Transmission oil temp.
- Engine coolant temp.

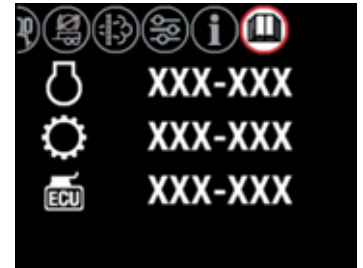

Service codes: Use Valtra Connect for further info!



Counter setting screen, where you can set the trigger used for counter ON/OFF, implement width and also reset the counter



Counter area/time - detailed info

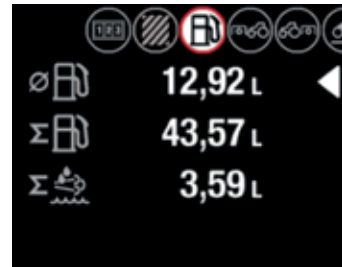

Counter - detailed info about fuel and AdBlue use



G135



VALTRA

YOUR WORKING MACHINE